

ATV12HU15M3

variable speed drive ATV12 - 1.5kW - 2hp -
200..240V - 3ph - with heat sink



Main

Range of product	Altivar 12
Product or component type	Variable speed drive
Product destination	Asynchronous motors
Product specific application	Simple machine
Assembly style	With heat sink
Component name	ATV12
Quantity per set	Set of 1
EMC filter	Without EMC filter
Built-in fan	With
Network number of phases	Three phase
[Us] rated supply voltage	200...240 V (- 15...10 %)
Motor power kW	1.5 kW
Motor power hp	2 hp
Communication port protocol	Modbus
Line current	9.3 A at 240 V 11.1 A at 200 V
Speed range	1...20
Transient overtorque	150...170 % of nominal motor torque depending on drive rating and type of motor
Asynchronous motor control profile	Quadratic voltage/frequency ratio Sensorless flux vector control Voltage/Frequency ratio (V/f)
IP degree of protection	IP20 without blanking plate on upper part
Noise level	50 dB

Complementary

Supply frequency	50/60 Hz (+/- 5 %)
Type of connector	1 RJ45 for Modbus on front face
Physical interface	2-wire RS 485 for Modbus
Transmission frame	RTU for Modbus
Transmission rate	38400 bit/s 19200 bit/s 9600 bit/s 4800 bit/s
Number of addresses	1...247 for Modbus
Communication service	Read device identification (43) Read/Write multiple registers (23), messaging: 4/4 words maximum Write multiple registers (16), messaging: 27 words maximum Write single register (06), messaging: 29 words maximum Read holding registers (03), messaging: 29 words maximum
Prospective line Isc	<= 5 kA
Continuous output current	7.5 A at 4 kHz
Maximum transient current	11.2 A for 60 s
Speed drive output frequency	0.5...400 Hz
Nominal switching frequency	4 kHz
Switching frequency	4...16 kHz with derating factor 2...16 kHz adjustable

The information provided in this documentation contains general descriptions and/or technical characteristics of the performance of the products contained herein. This documentation is not intended as a substitute for and is not to be used for determining suitability or reliability of these products for specific user applications. It is the duty of any such user or integrator to perform the appropriate and complete risk analysis, evaluation and testing of the products with respect to the relevant specific application or use thereof. Neither Schneider Electric Industries SAS nor any of its affiliates or subsidiaries shall be responsible or liable for misuse of the information contained herein.

Braking torque	Up to 70 % of nominal motor torque without braking resistor Up to 150 % of nominal motor torque with braking resistor at high inertia
Motor slip compensation	Adjustable Preset in factory
Output voltage	200...240 V three phase
Electrical connection	L1, L2, L3, U, V, W, PA, PC terminal 5.5 mm ² (AWG 10)
Tightening torque	1.2 N.m
Insulation	Electrical between power and control
Supply	Internal supply for logic inputs 24 V DC, voltage limits 20.4...28.8 V, 100 mA for overload and short-circuit protection Internal supply for reference potentiometer 5 V DC, voltage limits 4.75...5.25 V, 10 mA for overload and short-circuit protection
Analogue input number	1
Analogue input type	AI1 configurable voltage 0...5 V, impedance 30 kOhm AI1 configurable voltage 0...10 V, impedance 30 kOhm AI1 configurable current 0...20 mA, impedance 250 Ohm
Discrete input number	4
Discrete input type	(L11...L14) programmable, 24 V, voltage limits 18...30 V
Discrete input logic	Positive logic (source), 0...< 5 V (state 0), > 11 V (state 1) Negative logic (sink), > 16 V (state 0), < 10 V (state 1), input impedance 3.5 kOhm
Sampling duration	< 10 ms for analogue input < 20 ms, tolerance +/- 1 ms for logic input
Linearity error	+/- 0.3 % of maximum value for analogue input
Analogue output number	1
Analogue output type	(AO1) software-configurable current, analogue output range 0...20 mA, output impedance 800 Ohm, analogue output resolution 8 bits (AO1) software-configurable voltage, analogue output range 0...10 V, output impedance 470 Ohm, analogue output resolution 8 bits
Discrete output number	2
Discrete output type	(R1A, R1B, R1C) protected relay output 1 C/O (LO+, LO-) logic output
Minimum switching current	5 mA at 24 V DC for logic relay
Maximum switching current	4 A at 30 V DC resistive load cos phi = 1 L/R = 0 ms for logic relay 3 A at 250 V AC resistive load cos phi = 1 L/R = 0 ms for logic relay 2 A at 30 V DC inductive load cos phi = 0.4 L/R = 7 ms for logic relay 2 A at 250 V AC inductive load cos phi = 0.4 L/R = 7 ms for logic relay
Acceleration and deceleration ramps	Linear from 0 to 999.9 s S U
Braking to standstill	By DC injection, 0.1...30 s
Protection type	Thermal motor protection via the drive by continuous calculation of I ² t Against input phase loss in three-phase Short-circuit between motor phases Overheating protection Overcurrent between output phases and earth Line supply undervoltage Line supply overvoltage
Frequency resolution	Display unit 0.1 Hz Analog input converter A/D, 10 bits
Time constant	20 ms, tolerance +/- 1 ms for reference change
Marking	CE
Operating position	Vertical +/- 10 degree
Height	143 mm
Width	105 mm
Depth	131.2 mm
Product weight	1.2 kg

Environment

Electromagnetic compatibility	<p>Voltage dips and interruptions immunity test conforming to EN/IEC 61000-4-11</p> <p>Surge immunity test (level 3) conforming to EN/IEC 61000-4-5</p> <p>Radiated radio-frequency electromagnetic field immunity test (level 3) conforming to EN/IEC 61000-4-3</p> <p>Immunity to conducted disturbances (level 3) conforming to EN/IEC 61000-4-6</p> <p>Electrostatic discharge immunity test (level 3) conforming to EN/IEC 61000-4-2</p> <p>Electrical fast transient/burst immunity test (level 4) conforming to EN/IEC 61000-4-4</p>
Electromagnetic emission	<p>Conducted emissions with additional EMC filter, class: environment 2 category C3 conforming to EN/IEC 61800-3 - test level: 4...12 kHz, <= 20 m shielded motor cable</p> <p>Conducted emissions with additional EMC filter, class: environment 1 category C2 conforming to EN/IEC 61800-3 - test level: 4...12 kHz, <= 20 m shielded motor cable</p> <p>Conducted emissions with additional EMC filter, class: environment 1 category C1 conforming to EN/IEC 61800-3 - test level: 4...12 kHz, <= 5 m shielded motor cable</p> <p>Radiated emissions, class: environment 1 category C2 conforming to EN/IEC 61800-3 - test level: 2...16 kHz shielded motor cable</p>
Product certifications	<p>CSA</p> <p>C-Tick</p> <p>GOST</p> <p>NOM</p> <p>UL</p>
Vibration resistance	<p>1.5 mm peak to peak (f = 3...13 Hz) drive unmounted on symmetrical DIN rail conforming to EN/IEC 60068-2-6</p> <p>1 gn (f = 13...200 Hz) conforming to EN/IEC 60068-2-6</p>
Shock resistance	15 gn for 11 ms conforming to EN/IEC 60068-2-27
Relative humidity	<p>5...95 % without dripping water conforming to IEC 60068-2-3</p> <p>5...95 % without condensation conforming to IEC 60068-2-3</p>
Ambient air temperature for storage	-25...70 °C
Ambient air temperature for operation	<p>50...60 °C with current derating 2.2 % per °C</p> <p>-10...50 °C with protective cover from the top of the drive removed</p>
Operating altitude	<p>> 1000...3000 m with current derating 1 % per 100 m</p> <p><= 1000 m without derating</p>

Offer Sustainability

Sustainable offer status	Not Green Premium product
RoHS (date code: YYWW)	Compliant - since 0901 - Schneider Electric declaration of conformity

Dimensions

Drive without EMC Conformity Kit

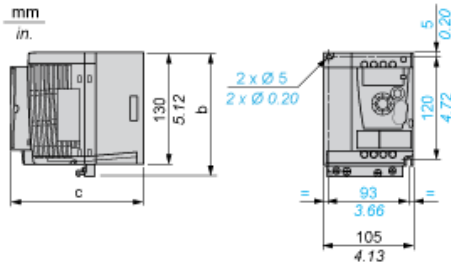

Dimensions in mm

b	c
143	131.2

Dimensions in in.

b	c
5.63	5.16

Drive with EMC Conformity Kit

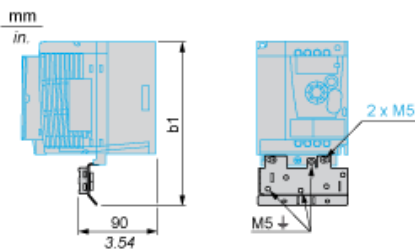

Dimensions in mm

b1
189.3

Dimensions in in.

b1
7.45

Mounting Recommendations

Clearance for Vertical Mounting

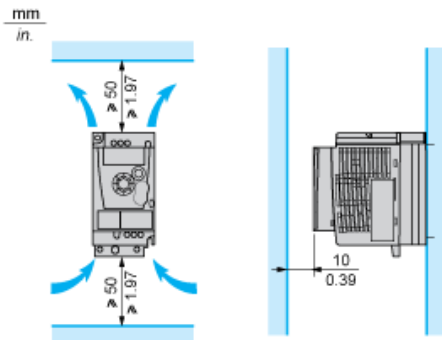

Mounting Type A

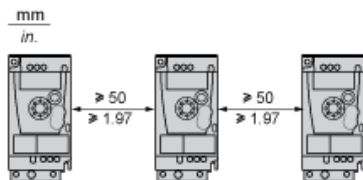

Mounting Type B

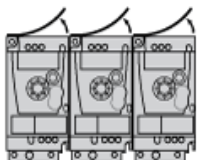

Remove the protective cover from the top of the drive.

Mounting Type C

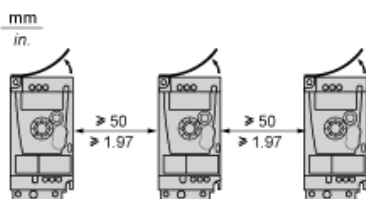

Remove the protective cover from the top of the drive.

Three-Phase Power Supply Wiring Diagram

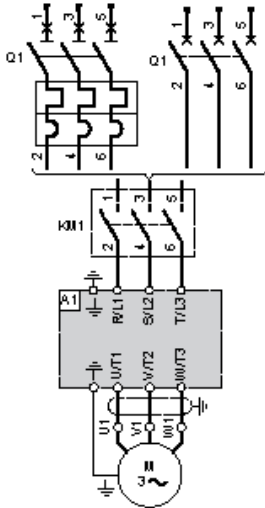

- A1 Drive
- KM1 Contactor (only if a control circuit is needed)
- Q1 Circuit breaker

Recommended Schemes

2-Wire Control for Logic I/O with Internal Power Supply

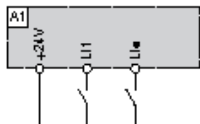

- L1 : Forward
- L1• : Reverse
- A1 : Drive

3-Wire Control for Logic I/O with Internal Power Supply

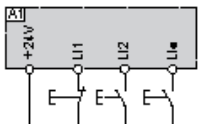

- L1 : Stop
- L12 : Forward
- L1• : Reverse
- A1 : Drive

Analog Input Configured for Voltage with Internal Power Supply

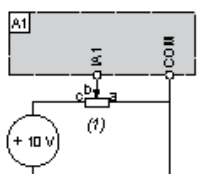

- (1) 2.2 kΩ...10 kΩ reference potentiometer
- A1 : Drive

Analog Input Configured for Current with Internal Power Supply

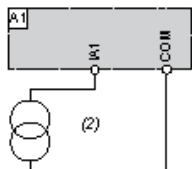

(2) 0-20 mA 4-20 mA supply
 A1 : Drive

Connected as Positive Logic (Source) with External 24 vdc Supply

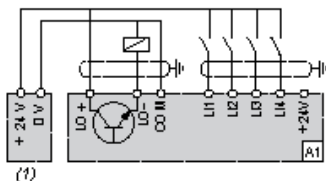

(1) 24 vdc supply
 A1 : Drive

Connected as Negative Logic (Sink) with External 24 vdc supply

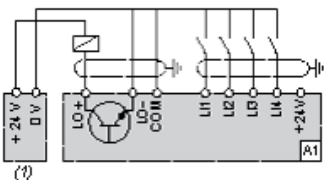

(1) 24 vdc supply
 A1 : Drive

Torque Curves

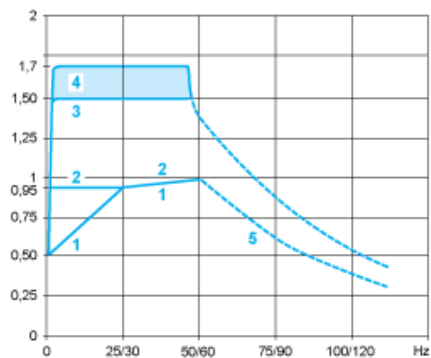

- 1 : Self-cooled motor: continuous useful torque (1)
 - 2 : Force-cooled motor: continuous useful torque
 - 3 : Transient overtorque for 60 s
 - 4 : Transient overtorque for 2 s
 - 5 : Torque in overspeed at constant power (2)
- (1) For power ratings ≤ 250 W, derating is 20% instead of 50% at very low frequencies.
(2) The nominal motor frequency and the maximum output frequency can be adjusted from 0.5 to 400 Hz. The mechanical overspeed capability of the selected motor must be checked with the manufacturer.